

# Brakemotors

TFP

Technical Data

Page 2

Dimensions

Page 6



## 11.0 DATI TECNICI







## 11.0 TECHNICAL DATA

## 11.0 TECHNISCHE DATEN

Le pagine seguenti riportano i dati tecnici dei motori trifase, monofase e autofrenanti a singola e doppia polarità. La simbologia sottostante, richiamata sopra le tabelle, faciliterà la ricerca del tipo di motore desiderato.

The following pages list the technical data of threephase, single phase and brake motors with single and double polarity. The symbols heading our tables will facilitate the search the required motor.

Auf den folgenden Seiten sind die technischen Daten zu den Drehstrom- und Einphasenmotoren sowie zu Bremsmotoren, in ein und doppelpoliger Version, aufgeführt. Die nachstehenden Kurzbezeichnungen, die in den Tabellen aufgeführt werden, erleichtern die Suche des gewünschten Motortyps.

<b>TN</b>		<b>Motori trifase standard</b> <i>Standard Threephase motors</i> Standard Drehstrommotoren	<b>2,4,6,8</b> poli <i>pole</i> polig
<b>TF</b> <b>TFP</b> <b>TFS</b>		<b>Motori trifase autofrenanti</b> <i>Threephase brake motors</i> Drehstrom- Bremsmotoren	
<b>DN</b>		<b>Motori trifase a doppia polarità</b> <i>Threephase two speed motors</i> Polumschaltbare - Drehstrommotoren	<b>2/4, 4/6, 4/8</b> <b>2/6, 2/8, 6/8</b> poli <i>pole</i> polig
<b>DF</b> <b>DFP</b> <b>DFS</b>		<b>Motori trifase autofrenanti a doppia polarità</b> <i>Threephase two speed brake motors</i> Polumschaltbare- Bremsmotoren	
<b>MN</b> <b>XN</b>		<b>Motori monofase standard</b> <i>Standard single phase motors</i> Standard Einphasenmotoren	<b>2, 4, 6</b> poli <i>pole</i> polig
<b>MF</b> <b>XF</b>		<b>Motori monofase autofrenanti standard</b> <i>Standard single phase brake motors</i> Standard Einphasenbremsmotoren	

### Simbologia

Grandezza	Denominazione	Unità di mis.
<b>P<sub>N</sub></b>	Potenza nominale	kW,HP
<b>n</b>	Velocità nominale	min <sup>-1</sup>
<b>η</b>	Rendimento	%
<b>cosφ</b>	Fattore di potenza	—
<b>I<sub>sp</sub></b>	Corrente di spunto	A
<b>I<sub>N</sub></b>	Corrente nominale	A
<b>M<sub>sp</sub></b>	Coppia di spunto	Nm
<b>M<sub>MAX</sub></b>	Coppia massima	Nm
<b>M<sub>N</sub></b>	Coppia nominale	Nm
<b>C</b>	Capacità condens.	μF
<b>U</b>	Tensione	V
<b>J</b>	Momento d'inerzia	Kgm <sup>2</sup>

(nel caso di motore autofrenante, al valore J riportato nelle tabelle, dovrà essere sommato quello del freno a c.c. o a c.a. riportato nella pagina relativa).

### Symbols



Size	Nomenclature	Unit of meas.
<b>P<sub>N</sub></b>	Nominal power	kW,HP
<b>n</b>	Nominal speed	min <sup>-1</sup>
<b>η</b>	Efficiency	%
<b>cosφ</b>	Power factor	—
<b>I<sub>sp</sub></b>	Starting current	A
<b>I<sub>N</sub></b>	Nominal current	A
<b>M<sub>sp</sub></b>	Starting torque	Nm
<b>M<sub>MAX</sub></b>	Max torque	Nm
<b>M<sub>N</sub></b>	Nominal torque	Nm
<b>C</b>	Capacitor capacity	μF
<b>U</b>	Tension	V
<b>J</b>	Moment of inertia	Kgm <sup>2</sup>

(In case of brake motors add to J value reported in the tables, the d.c. or a.c. brake value reported in relevant page)

### Kurzbezeichnungen



Größe	Bezeichnung	Maßeinheit
<b>P<sub>N</sub></b>	Nennleistung	kW,HP
<b>n</b>	Nenngeschwindigkeit	min <sup>-1</sup>
<b>η</b>	Wirkungsgrad	%
<b>cosφ</b>	Leistungsfaktor	—
<b>I<sub>sp</sub></b>	Anlaufstrom	A
<b>I<sub>N</sub></b>	Nennstrom	A
<b>M<sub>sp</sub></b>	Anlaufmoment	Nm
<b>M<sub>MAX</sub></b>	Maximalmoment	Nm
<b>M<sub>N</sub></b>	Nennmoment	Nm
<b>C</b>	Kondensatorskapazität	μF
<b>U</b>	Spannung	V
<b>J</b>	Trägheitsmoment	Kgm <sup>2</sup>

(beim Bremsmotor muß zum J-Wert der jeweilige Wert der Gs oder Ws-Bremse dazugezählt werden).

<b>TN</b>		<b>Motori trifase standard</b> <i>Standard Threephase motors</i> <b>Standard Drehstrommotoren</b>
<b>TF TFP TFS</b>		<b>Motori trifase autofrenanti</b> <i>Threephase brake motors</i> <b>Drehstrom- Bremsmotoren</b>

**2 poli/pole/polig 3000 rpm**

Tipo Type Typ	P <sub>N</sub> kW	P <sub>N</sub> HP	n <sub>n</sub> min <sup>-1</sup>	η %	cosφ	I <sub>N</sub> (400V) A	$\frac{I_{sp}}{I_N}$	M <sub>N</sub> Nm	$\frac{M_{sp}}{M_N}$	$\frac{M_{MAX}}{M_N}$	J Kgm <sup>2</sup>	Kg (TN)	Kg (TF)
55 A	0.05	0.07	1320	55	0.71	0.30	2.8	0.20	2	2.2	0.00010	2.0	—
56 A	0.09	0.12	2730	59	0.71	0.45	2.8	0.32	2	2.2	0.00011	2.9	4.0
56 B	0.13	0.18	2730	60	0.73	0.50	3	0.45	2	2.3	0.00012	3	4.1
63 A	0.18	0.25	2740	64	0.76	0.60	3.5	0.63	2	2.2	0.00016	3.7	5.1
63 B	0.25	0.33	2750	65	0.78	0.85	3.5	0.85	2.1	2.3	0.00019	4.6	6.0
63 C	0.37	0.50	2770	68	0.80	1	3.8	1.30	2	2.4	0.00029	4.7	6.1
71 A	0.37	0.50	2800	70	0.81	1.1	4.3	1.29	2.2	2.5	0.00036	5.5	6.9
71 B	0.55	0.75	2820	73	0.81	1.4	4.5	1.85	2.2	2.5	0.00047	6.5	7.9
71 C	0.75	1	2820	78	0.82	1.7	4.5	2.58	2.2	2.6	0.00057	7.2	8.6
80 A	0.75	1	2830	77	0.83	1.8	4.8	2.58	2.3	2.7	0.00085	8.7	10.6
80 B	1.1	1.5	2830	79	0.84	2.5	5	3.78	2.3	2.7	0.00105	10.8	12.7
90 S	1.5	2	2840	79	0.83	3.6	5.5	5.1	2.5	2.8	0.00145	12.9	16.0
90 L	2.2	3	2850	81	0.87	4.8	5.6	7.5	2.5	3.0	0.00191	14.8	17.9
100 A	3	4	2870	83	0.88	6.4	5.8	10	2.4	3.0	0.00299	22	27.6
100 B	4	5.5	2880	84	0.88	8.5	6.2	13.4	2.5	3.2	0.00407	27	32.6
112 A	4	5.5	2880	84	0.88	9.3	6.8	13.4	2.5	3.2	0.00520	29	38.7
112 B	5.5	7.5	2880	84	0.84	12.0	6.8	18.5	2.5	3.2	0.00700	32	41.7
132 SA	5.5	7.5	2860	85	0.88	11.5	6.5	18.3	2.4	3.0	0.01080	44	61
132 SB	7.5	10	2870	85	0.88	16.5	6.8	25	2.4	3.2	0.01300	50	67
132 MC	9.2	12.5	2880	85	0.88	19	6.8	30.6	2.4	3.2	0.01639	59	76
132 MD	11	15	2880	85	0.82	23	6.7	36.5	2.4	3.2	0.01873	65	82
160 MA	11	15	2920	88	0.87	21	7	36	2	2.2	0.03300	115	—
160 MB	15	20	2920	89	0.87	28	7	49	2	2.2	0.04500	125	—
160 L	18.5	25	2920	89	0.87	34	7	61.0	2	2.2	0.05400	145	—
180 M	22	30	2940	89	0.89	40	7	72.0	2	2.2	0.07300	173	—
200 LA	30	40	2940	90	0.89	54	7	98.0	2	2.2	0.12000	232	—
200 LB	37	50	2950	91	0.89	66	7	120	2	2.2	0.15000	250	—
225 M	45	60	2950	92	0.89	80	7	146	2	2.2	0.22000	312	—
250 M	55	75	2970	92	0.89	98	7	178	2	2.2	0.36000	387	—
280 S	75	100	2970	92	0.89	133	7	241	2	2.2	0.61000	515	—
280 M	90	125	2970	92	0.89	159	7	290	2	2.2	0.70000	566	—
315 S	110	150	2970	93	0.89	192	7	354	1.8	2.2	1.46000	922	—
315 MA	132	175	2980	93	0.89	229	7	423	1.8	2.2	1.70000	1010	—
315 MB	150	200	2980	94	0.89	276	7	481	1.8	2.2	2.00000	1085	—
315 LA	160	220	2980	94	0.89	288	6.8	513	1.8	2.2	2.00000	1200	—
315 LB	175	238	2980	94	0.89	304	6.8	561	1.8	2.2	2.08000	1250	—
315 LC	185	250	2980	94	0.89	321	6.8	593	1.8	2.2	2.20000	1250	—
315 LD	200	270	2980	94	0.89	347	6.8	641	1.8	2.2	2.20000	1250	—
355 MA	220	300	2980	95	0.89	377	6.8	705	1.2	2.2	2.60000	1750	—
355 MB	250	340	2981	95	0.90	422	6.8	801	1.2	2.2	2.97000	1770	—
355 LA	280	280	2982	95	0.90	472	6.8	897	1.2	2.2	3.77000	1830	—
355 LB	315	430	2981	96	0.90	530	6.8	1010	1.2	2.2	4.25000	1900	—

<b>TN</b>		<b>Motori trifase standard</b> <i>Standard Threephase motors</i> <b>Standard Drehstrommotoren</b>
<b>TF TFP TFS</b>		<b>Motori trifase autofrenanti</b> <i>Threephase brake motors</i> <b>Drehstrom- Bremsmotoren</b>

**4 poli/pole/polig 1500 rpm**

Tipo Type Typ	P <sub>N</sub> kW	P <sub>N</sub> HP	n <sub>n</sub> min <sup>-1</sup>	η %	cosφ	I <sub>N</sub> (400V) A	$\frac{I_{sp}}{I_N}$	M <sub>N</sub> Nm	$\frac{M_{sp}}{M_N}$	$\frac{M_{MAX}}{M_N}$	J Kgm <sup>2</sup>	Kg (TN)	Kg (TF)
55 A	0.05	0.07	1320	50	0.65	0.36	2	0.42	1.7	2	0.00010	2.0	—
56 B	0.09	0.12	1340	56	0.65	0.40	2.3	0.65	1.8	2	0.00018	2.9	4.0
63 A	0.13	0.18	1360	60	0.68	0.60	2.4	0.93	2	2.2	0.00025	3.7	5.1
63 B	0.18	0.25	1380	62	0.69	0.70	2.6	1.29	2.2	2.3	0.00029	4.5	5.9
71 A	0.25	0.33	1400	63	0.71	0.90	3	1.7	2.2	2.3	0.00074	5.4	6.8
71 B	0.37	0.50	1400	68	0.71	1.2	3.2	2.52	2.3	2.6	0.00096	6.4	7.8
71 C	0.55	0.75	1400	72	0.75	1.5	3.9	3.75	2.4	2.5	0.00117	7	8.4
80 A	0.55	0.75	1410	74	0.78	1.6	3.9	3.80	2.4	2.6	0.00191	8.5	10.4
80 B	0.75	1	1410	74	0.78	2.1	4	5	2.2	2.4	0.00254	10.5	12.4
80C	0.95	1.3	1410	74	0.78	2.8	4	6.56	2.3	2.6	0.00285	11.5	13.4
90 S	1.1	1.5	1410	74	0.78	3	4.3	7.5	2.2	2.4	0.00242	12.5	15.6
90 L	1.5	2	1420	78	0.80	3.8	4.6	10	2.3	2.6	0.00321	14	17.1
90 LB	1.8	2.5	1420	78	0.80	4.6	4.7	12.1	2.3	2.6	0.00400	16	19.1
100 A	2.2	3	1430	80	0.82	5.4	4.8	15	2.2	2.5	0.00520	20	25.6
100 B	3	4	1430	81	0.82	7	5	20	2.3	2.6	0.00668	24	29.6
112 A	4	5.5	1430	83	0.83	9	5.2	27	2.4	2.7	0.01052	29	38.7
112 B	5.5	7.5	1450	83	0.83	12.5	5.5	36.2	2.4	2.2	0.01320	32	41.7
132 SA	5.5	7.5	1430	83	0.83	12	6	37	2.5	2.8	0.01940	42	59
132 MB	7.5	10	1430	83	0.83	16	6.1	50	2.5	2.8	0.02688	53	70
132 MC	9.2	12.5	1430	85	0.85	18	6.1	62	2.5	2.8	0.03059	58	75
132 MD	11	15	1430	85	0.85	22.5	6	75.0	2.0	2.5	0.03632	69	81
160 M	11	15	1450	89	0.86	21	7	72.5	2.0	2.3	0.06800	122	—
160 L	15	20	1450	89	0.86	29	7	99	2.2	2.3	0.09200	142	—
180 M	18.5	25	1470	91	0.86	34	7	120	2.0	2.2	0.12800	174	—
180 L	22	30	1470	92	0.86	41	7	143	2.0	2.2	0.15200	192	—
200 L	30	40	1470	92	0.87	54	7	195	2.0	2.2	0.24900	253	—
225 S	37	50	1480	92	0.87	67	7	239	1.9	2.2	0.13920	294	—
225 M	45	60	1480	92	0.88	80	7	291	1.9	2.2	0.47400	327	—
250 M	55	75	1480	93	0.88	98	7	355	2.0	2.2	0.73600	381	—
280 S	75	100	1480	93	0.88	133	7	484	1.9	2.2	1.22000	535	—
280 M	90	125	1480	94	0.89	156	7	591	1.9	2.2	1.46000	634	—
315 S	110	150	1487	96	0.89	190	7	707	1.8	2.2	2.12000	912	—
315 MA	132	180	1487	94	0.89	227	7	848	1.8	2.2	2.54000	1048	—
315 MB	150	200	1487	95	0.89	274	7	964	1.8	2.2	2.97000	1105	—
315 LA	160	220	1486	95	0.87	288	6.8	1028	1.8	2.2	2.97000	1200	—
315 LB	185	250	1487	95	0.89	317	6.8	1189	1.8	2.2	3.18000	1205	—
315 LC	200	270	1487	95	0.89	343	6.8	1285	1.8	2.2	3.25000	1210	—
355 MA	220	300	1488	95	0.87	386	6.8	1413	1.3	2.2	5.70000	1720	—
355 MB	250	340	1489	95	0.87	437	6.8	1604	1.3	2.2	6.48000	1800	—
355 LA	280	380	1489	95	0.87	488	6.8	1797	1.3	2.2	7.40000	1860	—
355 LB	315	430	1488	96	0.87	547	6.8	2023	1.3	2.2	8.20000	1940	—

**TN**

**Motori trifase standard**  
**Standard Threephase motors**  
**Standard Drehstrommotoren**
**TF  
TFP  
TFS**

**Motori trifase autofrenanti**  
**Threephase brake motors**  
**Drehstrom- Bremsmotoren**
**6 poli /pole/polig 1000 rpm**

Tipo Type Typ	P <sub>N</sub> kW	P <sub>N</sub> HP	n <sub>n</sub> min <sup>-1</sup>	η %	cosφ	I <sub>N</sub> (400V) A	$\frac{I_{sp}}{I_N}$	M <sub>N</sub> Nm	$\frac{M_{sp}}{M_N}$	$\frac{M_{MAX}}{M_N}$	J Kgm <sup>2</sup>	Kg (TN)	Kg (TF)
<b>56 C</b>	0.06	0.08	840	48	0.59	0.4	2.2	0.68	1.8	2	0.00018	3	4.1
<b>63 A</b>	0.09	0.12	850	52	0.60	0.5	2.2	1	1.8	2	0.00029	3.8	5.2
<b>63 B</b>	0.12	0.16	870	54	0.60	0.6	2.3	1.3	1.8	2	0.00034	4.6	6.0
<b>71 A</b>	0.18	0.25	880	56	0.62	0.8	2.5	1.95	1.8	2	0.00074	5.5	6.9
<b>71 B</b>	0.25	0.33	900	60	0.65	1	2.9	2.65	1.9	2.2	0.00096	6.5	7.9
<b>80 A</b>	0.37	0.50	910	62	0.66	1.27	3.2	3.88	1.9	2.2	0.00191	8.5	10.4
<b>80 B</b>	0.55	0.75	910	66	0.70	1.8	3.5	5.77	2	2.3	0.00254	10.5	12.4
<b>90 S</b>	0.75	1	920	68	0.70	2.4	3.5	7.79	1.8	2	0.00242	12.5	15.6
<b>90 L</b>	1.1	1.5	920	70	0.70	3.4	3.5	11.4	1.8	2	0.00398	14	17.1
<b>100 A</b>	1.5	2	940	75	0.72	4.2	4	15.2	1.8	2	0.00519	24	29.6
<b>112 A</b>	2.2	3	940	80	0.77	5.7	5	22.4	1.9	2.4	0.00720	34	43.7
<b>132 SA</b>	3	4	940	82	0.78	7.6	5.4	30.5	2	2.5	0.01940	44	61
<b>132 MB</b>	4	5.5	940	82	0.80	9	5.3	40.5	2	2.5	0.02688	55	72
<b>132 MC</b>	5.5	7.5	940	82	0.80	12.7	5.3	57	2	2.5	0.03430	60	77
<b>160 M</b>	7.5	10	960	87	0.77	16.5	6.5	75	2.0	2.3	0.09300	110	—
<b>160 L</b>	11	15	960	88	0.79	23	6.5	110	2.0	2.3	0.12700	130	—
<b>180 L</b>	15	20	970	90	0.81	30	6.5	148	1.8	2.0	0.19200	1892	—
<b>200 LA</b>	18.5	25	970	90	0.83	36	6.5	182	1.8	2.0	0.28100	220	—
<b>200 LB</b>	22	30	970	90	0.83	43	6.5	217	1.8	2.0	0.32400	246	—
<b>225 M</b>	30	40	980	90	0.85	57	6.5	293	1.7	2.0	0.73600	294	—
<b>250 M</b>	37	50	980	91	0.86	69	6.5	361	1.8	2.0	1.01000	395	—
<b>280 S</b>	45	60	980	92	0.87	81	6.5	439	1.8	2.0	1.48000	505	—
<b>280 M</b>	55	75	980	92	0.87	99	6.5	536	1.8	2.0	1.78000	566	—
<b>315 S</b>	75	100	988	93	0.87	134	6.5	725	1.6	2.0	2.63000	850	—
<b>315 MA</b>	90	125	988	93	0.87	161	6.5	870	1.6	2.0	3.08000	1050	—
<b>315 MB</b>	110	150	988	94	0.87	195	6.5	1064	1.6	2.0	3.63000	1110	—
<b>315 MC</b>	132	180	989	96	0.87	234	6.7	1275	1.6	2.0	4.17000	1120	—
<b>355 MA</b>	160	220	990	94	0.86	285	6.7	1544	1.3	2.0	10.7000	1590	—
<b>355 MB</b>	185	250	990	95	0.86	234	6.7	1785	1.3	2.0	11.8000	1680	—
<b>355 MC</b>	200	270	990	95	0.86	355	6.7	1930	1.3	2.0	12.7000	1750	—

**8 poli /pole/polig 750 rpm**

Tipo Type Typ	P <sub>N</sub> kW	P <sub>N</sub> HP	n <sub>n</sub> min <sup>-1</sup>	η %	cosφ	I <sub>N</sub> (400V) A	$\frac{I_{sp}}{I_N}$	M <sub>N</sub> Nm	$\frac{M_{sp}}{M_N}$	$\frac{M_{MAX}}{M_N}$	J Kgm <sup>2</sup>	Kg (TN)	Kg (TF)
<b>63 B</b>	0.07	0.10	660	42	0.56	0.6	1.3	1	1.8	2	0.00029	4.5	5.9
<b>71 B</b>	0.12	0.16	670	46	0.60	0.8	2	1.72	1.8	2	0.00096	6.5	7.9
<b>80 A</b>	0.18	0.25	690	50	0.60	0.9	2.5	2.5	1.8	2	0.00191	8.4	10.3
<b>80 B</b>	0.25	0.33	700	50	0.60	1	2.5	3.4	1.8	2	0.00254	10.4	12.3
<b>90 S</b>	0.37	0.5	700	58	0.60	1.6	3	5	2	2.2	0.00242	12.3	15.4
<b>90 L</b>	0.55	0.75	700	62	0.62	2.2	3.2	7.5	2	2.2	0.00320	13.8	16.9
<b>100 A</b>	0.75	1	700	70	0.64	2.6	3.5	10.4	2	2.4	0.00519	23	28.6
<b>100 B</b>	1.1	1.5	700	72	0.64	3.6	3.5	15.2	2	2.4	0.00668	30	35.6
<b>112 A</b>	1.5	2	700	74	0.66	4.7	4	20.7	2.1	2.4	0.01220	33	42.7
<b>132 SA</b>	2.2	3	700	75	0.65	7	4.1	30	2.2	2.4	0.01940	44	61
<b>132 MB</b>	3	4	700	77	0.65	9	4.3	41	2.2	2.4	0.03430	55	72
<b>160 MA</b>	4	5.5	710	80	0.70	9.8	4.5	54	1.8	2	0.07900	110	130
<b>160 MB</b>	5.5	7.5	720	84	0.74	11.6	5	73	1.8	2	0.10500	122	149
<b>160 L</b>	7.5	10	720	85	0.75	16.8	5	100	1.8	2	0.14300	144	169

14.2 Dimensioni serie FP  
 Dimensions FP series  
 Abmessungen Serie FP

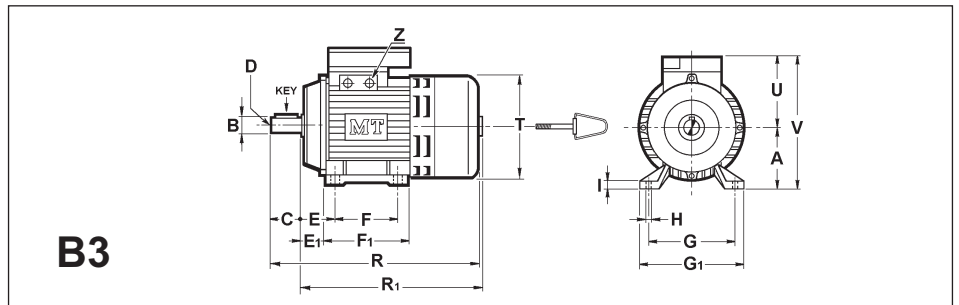
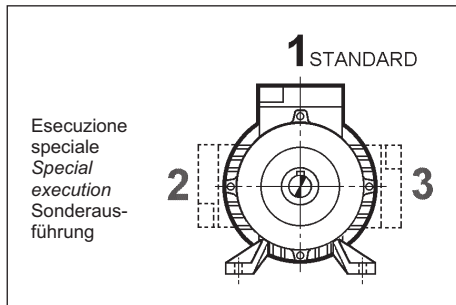
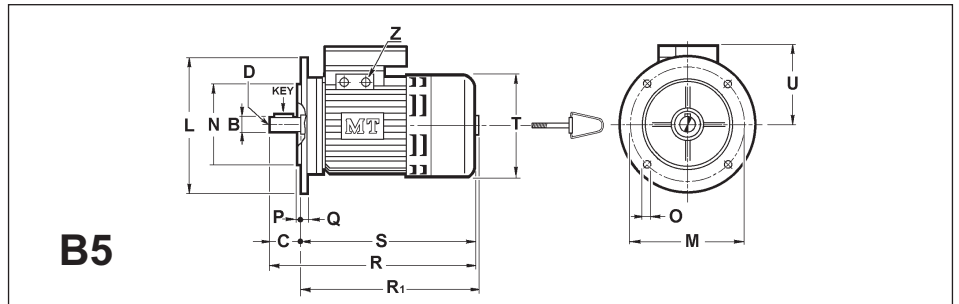
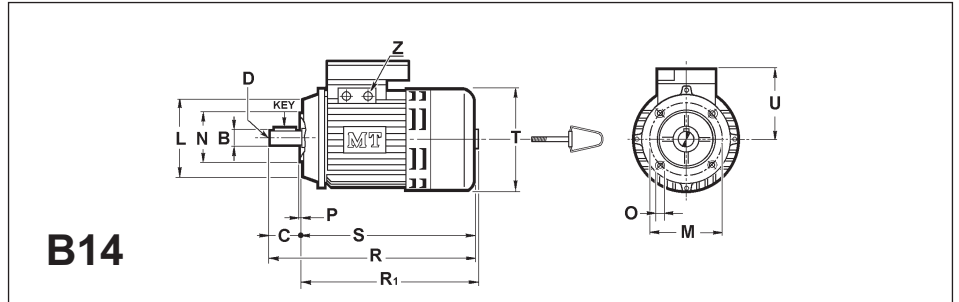
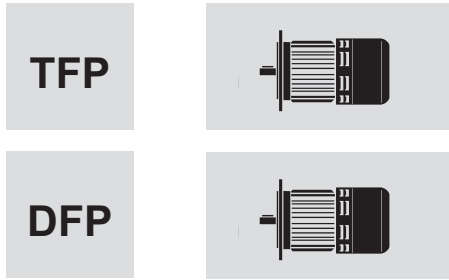

	<b>B3</b>										<b>B14</b>					
	<b>A</b>	<b>E</b>	<b>E1</b>	<b>F</b>	<b>F1</b>	<b>G</b>	<b>G1</b>	<b>H</b>	<b>I</b>	<b>V</b>	<b>L</b>	<b>M</b>	<b>N</b>	<b>O</b>	<b>P</b>	<b>S</b>
<b>63</b>	63	40	28	80	105	100	120	7	10	168	90	75	60	M5	2.5	272
<b>71</b>	71	45	36	90	108	112	136	7	11	185	105	85	70	M6	2.5	303
<b>80</b>	80	50	38	100	125	125	154	9.5	11	206	120	100	80	M6	3	332
<b>90 S</b>	90	56	41	100	130	140	174	9.5	13	223	140	115	95	M8	3	355
<b>90 L</b>	90	56	41	125	155	140	174	9.5	13	223	140	115	95	M8	3	380
<b>100</b>	100	63	46	140	175	160	192	12	14	242	160	130	110	M8	3.5	415
<b>112</b>	112	70	53	140	180	190	234	12	14	265	160	130	110	M8	3.5	435
<b>132 S</b>	132	89	60	140	180	216	256	12	16	310	200	165	130	M10	4	544
<b>132 M</b>	132	89	60	178	218	216	256	12	16	310	200	165	130	M10	4	582
<b>160 M</b>	160	108	82	210	260	254	310	15	22	400	250	215	180	M10	4	665
<b>160 L</b>	160	108	82	254	320	254	330	15	22	400	250	215	180	M10	4	700
<b>180</b>	180	121	96	279	329	279	359	13	25	436	—	—	—	—	—	—
<b>200</b>	200	133	108	305	355	318	398	20.5	25	456	—	—	—	—	—	—

	<b>B3 - B5 - B14</b>									<b>B5</b>						
	<b>B</b>	<b>C</b>	<b>D</b>	<b>R</b>	<b>R1</b>	<b>T</b>	<b>U</b>	<b>Z</b>	<b>Key</b>	<b>L</b>	<b>M</b>	<b>N</b>	<b>O</b>	<b>P</b>	<b>Q</b>	<b>S</b>
<b>63</b>	11	23	M4	305	295	124	105	M16x1.5	4x4x15	140	115	95	9	3	9	272
<b>71</b>	14	30	M5	333	313	140	114	M20x1.5	5x5x20	160	130	110	9	3.5	9	303
<b>80</b>	19	40	M6	372	342	158	126	M20x1.5	6x6x30	200	165	130	11	3.5	10	332
<b>90 S</b>	24	50	M8	405	365	178	133	M20x1.5	8x7x40	200	165	130	11	3.5	10	355
<b>90 L</b>	24	50	M8	430	390	178	133	M20x1.5	8x7x40	200	165	130	11	3.5	10	380
<b>100</b>	28	60	M10	475	425	198	142	M20x1.5	8x7x40	250	215	180	14	4	14	415
<b>112</b>	28	60	M10	495	445	222	153	M20x1.5	8x7x40	250	215	180	14	4	14	435
<b>132 S</b>	38	80	M12	624	554	255	178	M32x1.5	10x8x70	300	265	230	14	4	20	544
<b>132 M</b>	38	80	M12	662	592	255	178	M32x1.5	10x8x70	300	265	230	14	4	20	582
<b>160 M</b>	42	110	M16	775	671	317	340	M32x1.5	12x8x90	350	300	250	19	5	16	665
<b>160 L</b>	42	110	M16	819	715	317	340	M32x1.5	12x8x90	350	300	250	19	5	16	709
<b>180</b>	48	110	M16	940	935	360	256	M32x1.5	14x8	350	300	250	19	5	20	830
<b>200</b>	55	110	M20	955	850	360	256	M32x1.5	16x10	400	350	300	19	5	20	845